

凡例

	H150
	H200
	H300
	四角支柱
	建地補強位置
	控えワイヤー位置

平面図

1/200

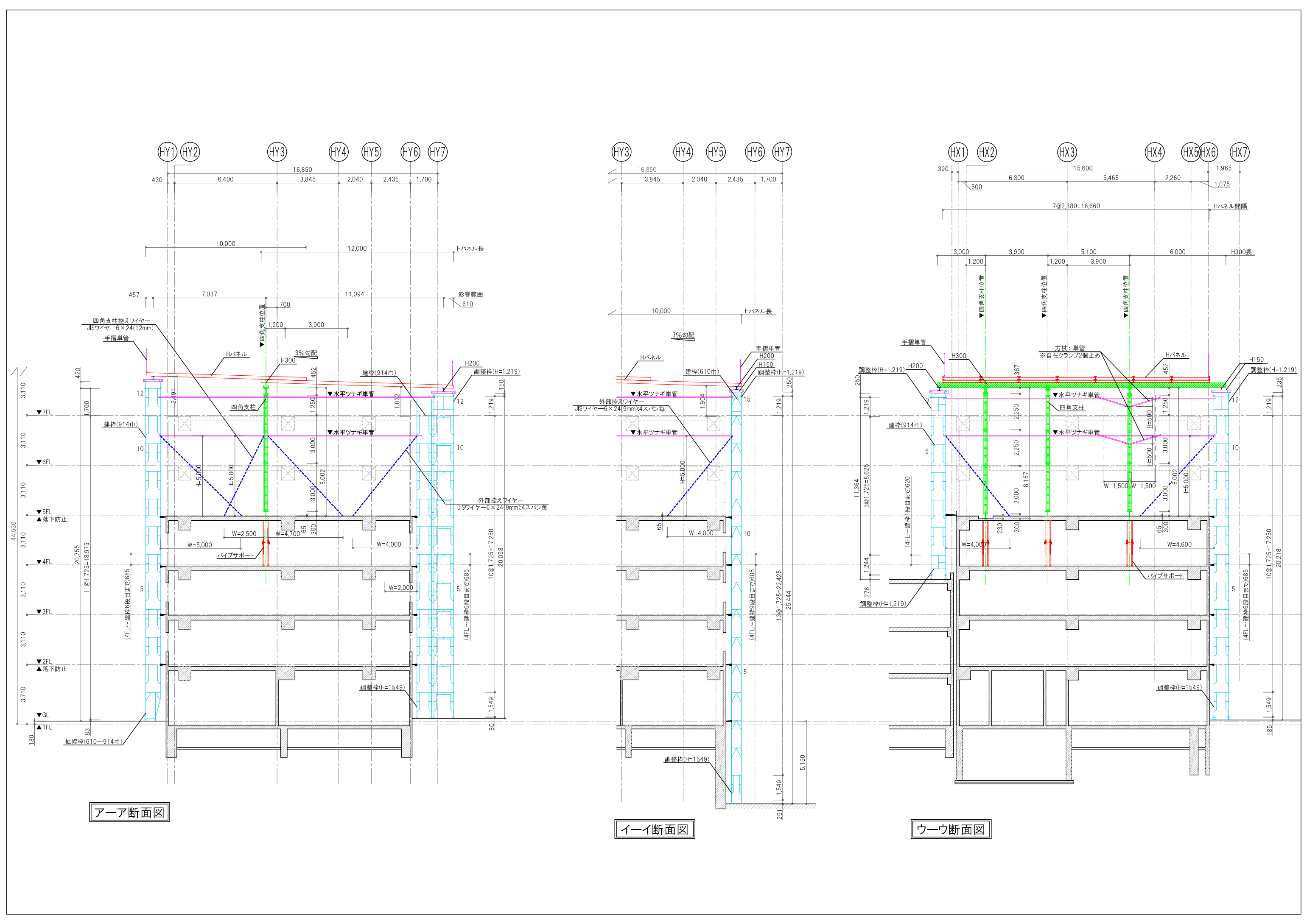

ア-ア断面図

イ-イ断面図

ウ-ウ断面図

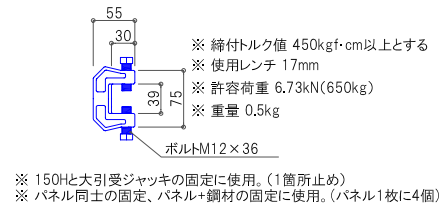

ロックマンミニ(形状・寸法)

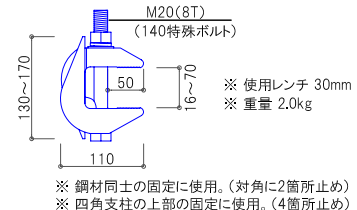

ロコチャック(形状・寸法)

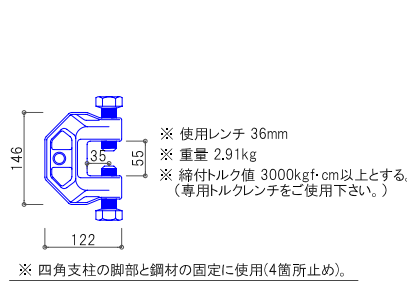

ロックマン(形状・寸法)

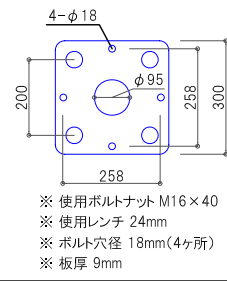

四角支柱(形状・寸法)

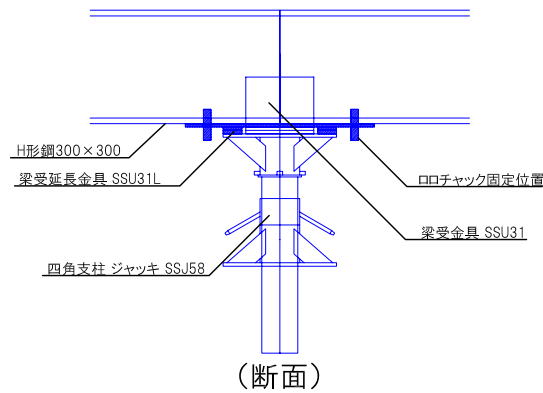
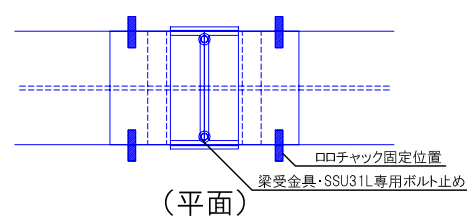

桁材継ぎ部分詳細図(1本受け)

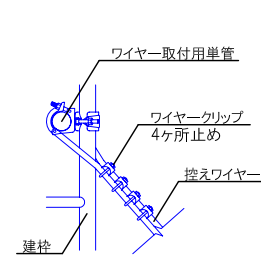

控えワイヤー詳細図(建柱)

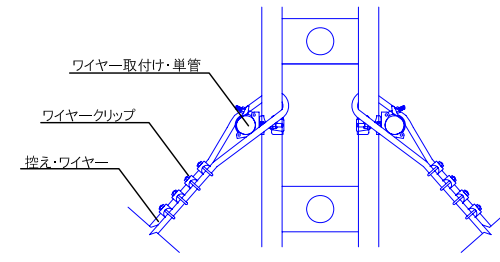

控えワイヤー詳細図(四角支柱)

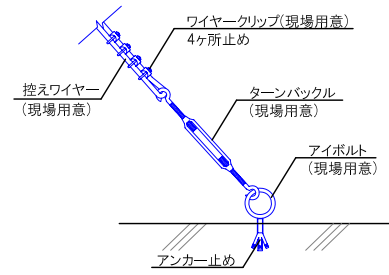

控えワイヤー詳細図(躯体側)

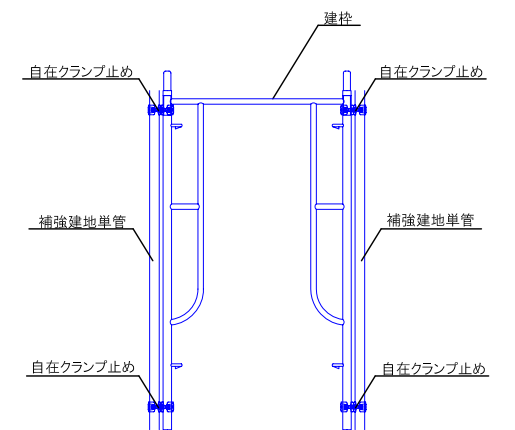
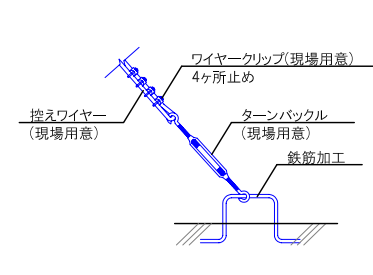

建柱補強詳細図

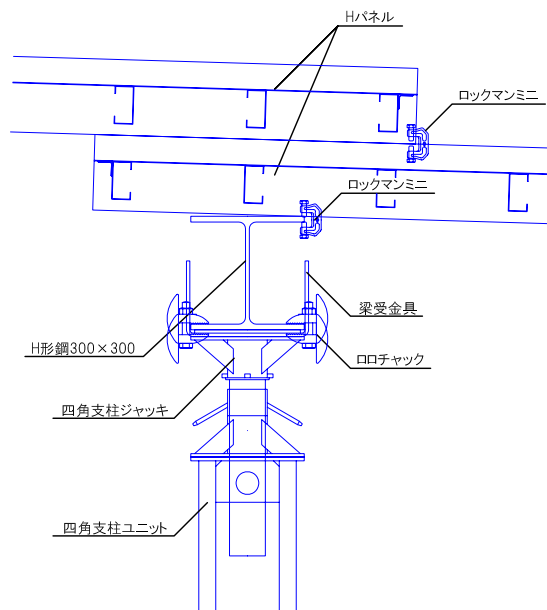

四角支柱上部詳細図

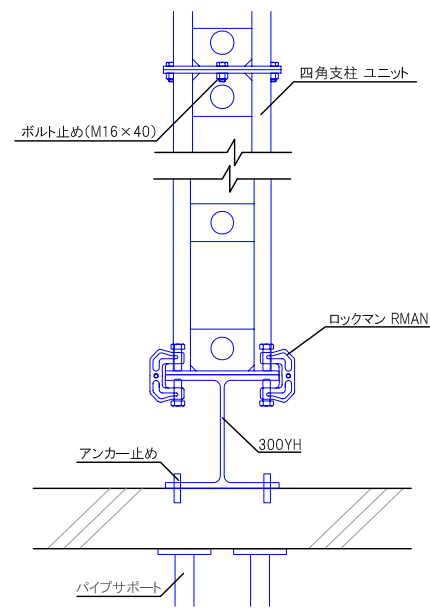

四角支柱脚部詳細図

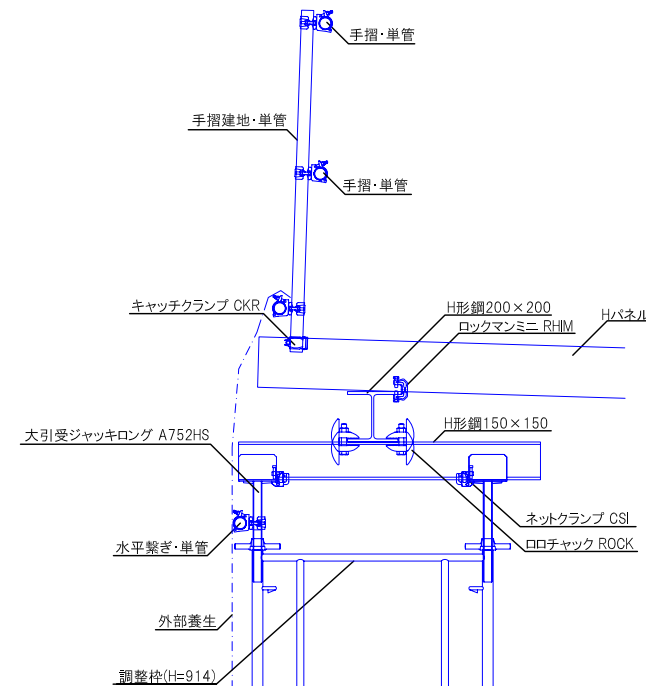

断面詳細図(水上)

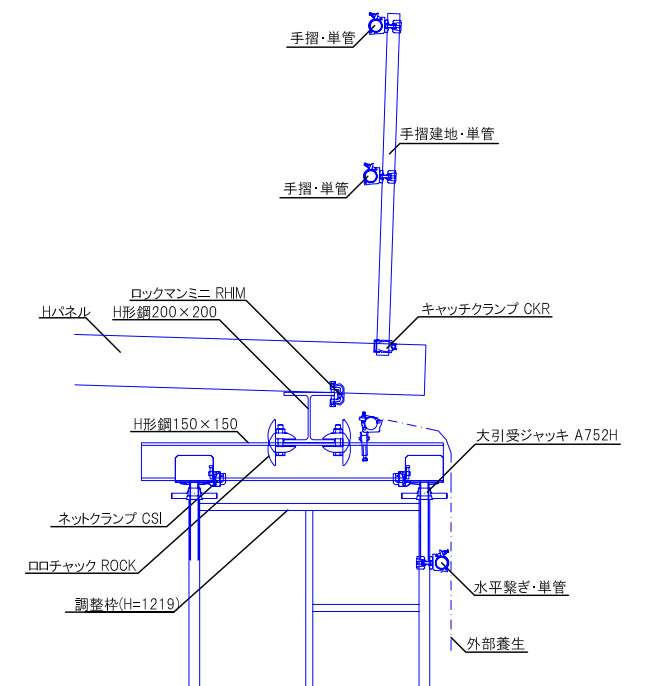

断面詳細図(水下)